



15HP

Motor	SVM-100S	SVM-100M	SVM-100L
Rated voltage $U_N$	220 / 380	220 / 380	220 / 380
Rated power output $P_N$	5.5kw	7.5kw	11kw
Rated speed $N_N$	1500rpm		
Rated torque $M_N$	35.0Nm	47.8Nm	69.4Nm
Rated current $I_N$	20.3/11.72	27.7/15.9	40.6/23.4
Efficiency	0.85		
Max speed $N_{max}$ Standard bearing	8000rpm		
Max current $I_{max}$	33/19.0A	36/20.78A	44/25.4A
Weight	51kg	68kg	83kg
Rated inertia $J$	245kgcm <sup>2</sup>	353kgcm <sup>2</sup>	405kgcm <sup>2</sup>
Protection	IP54		
Fan Rated voltage $U_L$ Frequency $f_L$	1Ø220V 50HZ/60HZ		

Motor	Rated speed	Rated power in duty type in accordance		Rated torque	Rated current for duty type		Rated power for duty type		Moment of inertia	Weight
	$M_{rated}$	M2			$I_{rated}$ (220/380v)				J	W
		S1	S6~60%		S1	S6~60%	S1	S6~60%		
TYPE	rpm	rpm	rpm	Nm	A	A	KW	KW	kgm <sup>2</sup>	kg
SVM-100S-10	1000	5000	4800	35.5	13.86/8	17.7/10.2	3.75	4.8	0.0245	51
SVM-100S-15	1500	7500	7200	35	20.3/11.72	25.87/14.9	5.5	7	0.0245	51
SVM-100S-20	2000	8000	7680	35.5	27.7/15.9	35.8/20.6	7.5	9.7	0.0245	51
SVM-100M-10	1000	5000	4800	52	20.3/11.7	26.2/15.1	5.5	7.1	0.0353	68
SVM-100M-15	1500	7500	7200	47.8	27.7/15.9	36.2/20.9	7.5	9.8	0.0353	68
SVM-100M-20	2000	8000	7680	52.06	40.6/23.4	52.8/30.4	11	14.3	0.0353	68
SVM-100L-10	1000	5000	4800	71	27.7/15.9	35.8/20.6	7.5	9.7	0.0405	83
SVM-100L-15	1500	7500	7200	69.4	40.6/23.4	51.7/29.8	11	14	0.0405	83
SVM-100L-20	2000	8000	7680	71	55.4/31.9	66.5/38.3	15	18	0.0405	83



外觀尺寸

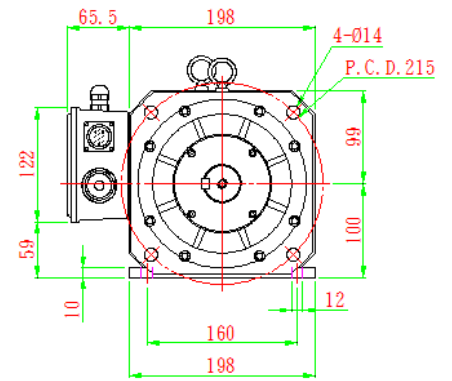
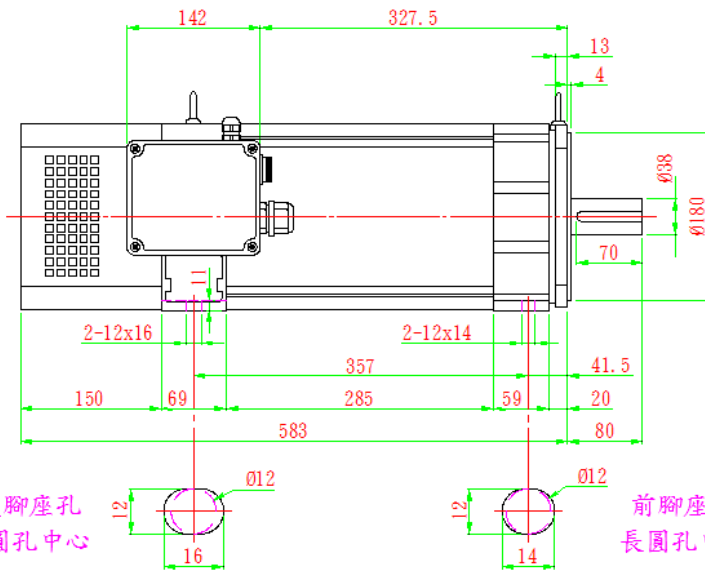

軸心公差:  $\pm 0.005$   
 引導公差:  $+0$   
 $-0.04$